

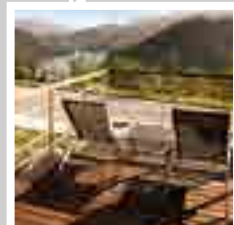

SIPHONS ABLÄUFE



Ø 300



## HL Proizvodi





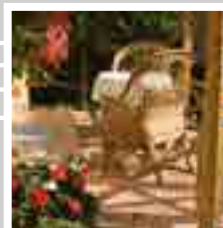



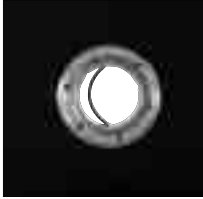
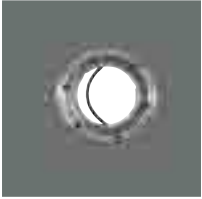

14. Hidroizolacione garniture  
Ø 145 Nastavni elementi

# 14



## HL Hidroizolacione garniture – Proizvodi – Pregled

Dodatne podatke o hidroizolacionim garniturama možete pronaći u poglavlju podni slivnici, podoravni tuševi, balkoni/terase i građevinska hidroizolacija

Za modele slivnika	Vrsta hidroizolacionog materijala		
	Za alternativne hidroizolacije povezane sa keramičkim pločicama kao na primer epoksidni ili 2-komponentni-fleks- premazi	Za EPDM-trake, bitumenske pre-maze i za lepljenje sa bitumenskim kragnama	Za zavarivanje sa bitumenskim kragnama
HL83.M = HL70, HL80, HL90, HL92, HL300, HL304, HL310N, HL510N			
Nastavni element: HL85N	<b>HL83.M</b>	<b>HL83</b>	<b>HL83.H *</b>
HL3100(T) i HL5100(T)			
Nastavni element: HL8500	<b>HL8300.M</b>	<b>HL8300</b>	<b>HL8300.H *</b>
HL72.1 i HL317			
Nastavni element: HL350.1	<b>HL84.M</b>	<b>HL84</b>	<b>**</b>
HL615 i HL616			
Nastavni element: HL618	<b>HL86.M</b>	<b>HL86</b>	<b>HL86.H</b>
Modeli krovnih slivnika HL62, HL63, HL64 i HL69			
Nastavni element: HL65	–	–	<b>HL84.H</b>

\* isto je i sa slivnikom na koji je fabrički spojena bitumenska hidroizolacija isporučivo kod serije slivnika HL80, HL615, HL616 kao i za seriju krovnih slivnika HL62, HL64, HL63, HL69 i nastavni elemenata HL85, HL618, HL65











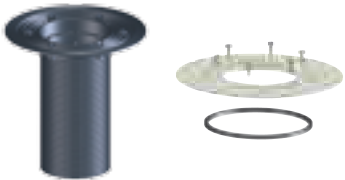
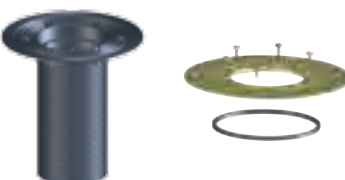



\*\* isporučivo sa fabrički spojenom hidroizolacijom!

\*\*\* stezno spajanje slivnika i krovne hidroizolacije sa INOX-prstenom

PVC-folije	FPO-folije odnosno TPO-folije	Za stezno spajanje sa elastičnim hidroizolacionim folijama	Za krovove pokrivena bakarnim limom	Za krovove pokrivena pocinkovanim limom
			-	-
HL83.P	HL83.PP	HL83.0		
			-	-
HL8300.P	HL8300.PP	HL8300.0		
***	***		-	-
		HL84.0		
***	***		-	-
		HL86.0		
**	**	**		
			HL84.CU	HL84.E

## HL Nastavni elementi – Proizvodi – Pregled

Za modele slivnika	Za podešavanje visine prirubnice na nivo alternativne hidroizolacije	Za podešavanje visine prirubnice slivnika na nivo hidroizolacije	Za podešavanje visine prirubnice slivnika na nivo bitumenske hidroizolacije	
HL70, HL80, HL90, HL300, HL304, HL310N, HL510N				
	<b>HL85NC ili HL85N + HL83.M</b>	<b>HL85N</b>	<b>HL85NH</b>	
HL3100 i HL5100				
	<b>HL8500 + HL8300.M</b>	<b>HL8500</b>	<b>HL8500H</b>	
HL72.1 i HL317				
	<b>HL360 ili HL370 ili HL350.0</b>	<b>HL350.0</b>	<b>HL350.1H</b>	
HL615 i HL616				
	<b>HL618 + HL86.M</b>	<b>HL618</b>	<b>HL618H</b>	
Modeli krovnih slivnika HL62 i HL64				
	-	<b>HL65</b>	<b>HL65H</b>	
Balkonski i terasni slivnik HL92				
	-	-	-	

Za podešavanje visine prirubnice slivnika na nivo PVC-hidroizolacije	Za podešavanje visine prirubnice slivnika na nivo FPO odnosno TPO-hidroizolacije	Za produžavanje završnog okvira
		
<p>HL85N + HL83.P</p>	<p>HL85N + HL83.PP</p>	<p>HL340N</p>
		
<p>HL8500 + HL8300.P</p>	<p>HL8500 + HL8300.PP</p>	<p>HL3400</p>
		
<p>HL350.0</p>	<p>HL350.0</p>	<p>HL350</p>
		
<p>HL618 + HL86.0</p>	<p>HL618 + HL86.0</p>	<p>HL620</p>
		
<p>HL65P</p>	<p>HL65F (HL65PE)</p>	<p>HL350</p>
<p>-</p>	<p>-</p>	
<p>-</p>	<p>-</p>	<p>HL320</p>

# HL Hidroizolacione garniture – Proizvodi – Podaci

## HL83.0, HL8300.0, HL84.0, HL86.0 Garnitura bez folije

### Podaci

Materijal	INOX
Dimenzija	<b>HL83.0:</b> Ø 196 x 114 mm <b>HL8300.0:</b> Ø 238 x 148 mm <b>HL84.0:</b> Ø 220 x 155 mm <b>HL86.0:</b> Ø 278 x 198 mm
Preporučeno za	stezno spajanje krovne izolacije sa priрубnicom slivnika
Odgovara za	<b>HL83.0:</b> HL70, HL80, HL90(Pr), HL92, HL300, HL304, HL310N(Pr), HL510N(Pr) kao i za nastavni element HL85N <b>HL8300.0:</b> HL3100(Pr) i HL5100(Pr) kao i za nastavni element HL8500 <b>HL84.0:</b> HL72.1 i HL317 <b>HL86.0:</b> HL615 i HL616 kao i za nastavni element HL618

### HL83.0

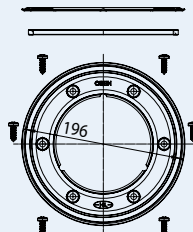

### HL8300.0

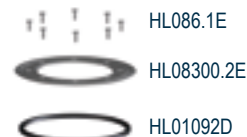
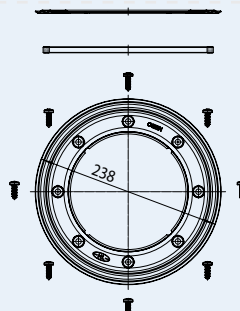

### HL84.0

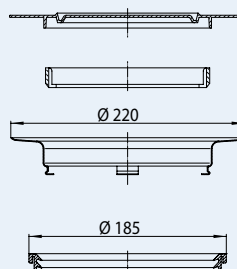

### HL86.0

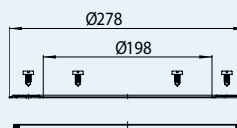

HL-br.	Težina	EAN	Kom./Pak.
83.0	245 g	+718306	1
8300.0	303 g	+025497	1
84.0	395 g	+718405	1
86.0	340 g	+711864	1

**HL83.M, HL8300.M, HL84.M, HL86.M** Dichtung garnitura sa diht-folijom lamirana vlaknom

**Podaci**

Materijal	INOX / diht-folija laminirana vlaknom
Dimenzija	<b>HL83.M:</b> Prirubnica Ø 196 x 114 mm, diht-folija lamirana vlaknom 400 x 500 mm <b>HL8300.M:</b> Prirubnica Ø 238 x 148 mm diht-folija lamirana vlaknom 500 x 500 mm <b>HL84.M:</b> Prirubnica Ø 220 x 155 mm diht-folija lamirana vlaknom 500 x 500 mm <b>HL86.M:</b> Prirubnica Ø 278 x 198 mm diht-folija lamirana vlaknom 500 x 500 mm
Preporučeno za	Za alternativne hidroizolacije povezane sa keramičkim pločicama kao na primer epoksidni, jedno- ili dvokomponentni-fleks- premazi
Odgovara za	<b>HL83.M:</b> HL70, HL80, HL90(Pr), HL92, HL300, HL304, HL310N(Pr), HL510N(Pr) kao i za nastavni element HL85N <b>HL8300.M:</b> HL3100(Pr) und HL5100(Pr) kao i za nastavni element HL8500 <b>HL84.M:</b> HL72.1 und HL317 <b>HL86.M:</b> HL615 und HL616 kao i za nastavni element HL618

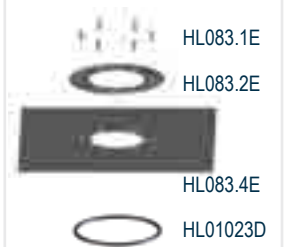
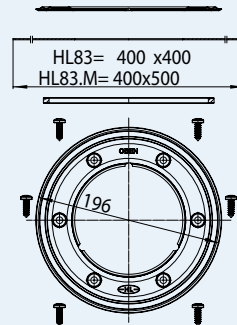
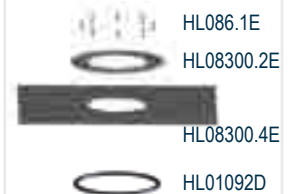
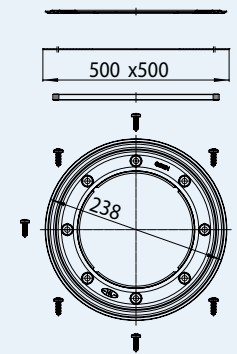
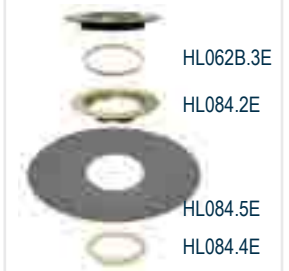
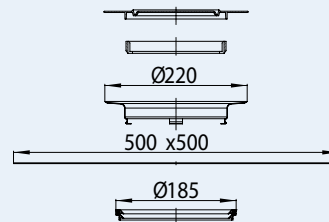
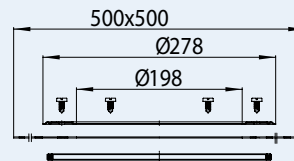
**HL83.M**

**HL8300.M**

**HL84.M**

**HL86.M**

HL-br.	Težina	EAN	Kom./Pak.
83.M	425 g	+030835	1
8300.M	425 g	+025473	1
84.M	730 g	+030842	1
86.M	590 g	+713868	1

## HL83, HL8300, HL84, HL86 Hidroizolaciona garnitura sa EPDM-folijom

### Podaci

Materijal	INOX / EPDM-folija
Dimenzija	<p><b>HL83:</b> Prirubnica Ø 196 x 114 mm EPDM-folija 400 x 400 mm</p> <p><b>HL8300:</b> Prirubnica Ø 238 x 148 mm EPDM-folija 500 x 500 mm</p> <p><b>HL84:</b> Prirubnica Ø 220 x 155 mm EPDM-folija 500 x 500 mm</p> <p><b>HL86:</b> Prirubnica Ø 278 x 198 mm EPDM-folija 500 x 500 mm</p>
Preporučeno za	Za EPDM-trake, bitumsenske premaze i za lepljenje sa bitumenskim kragnama
Odgovara za	<p><b>HL83:</b> HL70, HL80, HL90(Pr), HL92, HL300, HL304, HL310N(Pr), HL510N(Pr) kao i za nastavni element HL85N i HL5100(Pr) kao i za nastavni element HL8500</p> <p><b>HL84:</b> HL72.1 i HL317</p> <p><b>HL86:</b> HL615 i HL616 kao i za nastavni element HL618</p>

### HL83

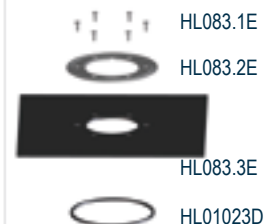
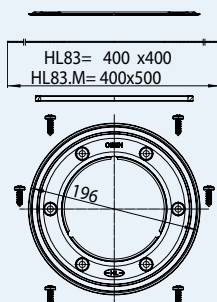

### HL8300

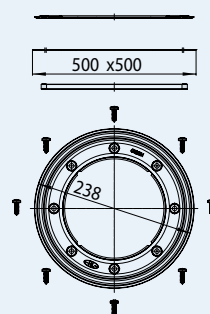
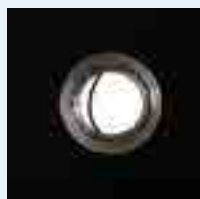

### HL84

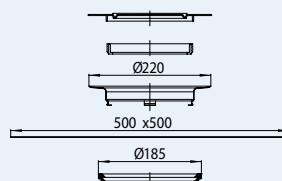
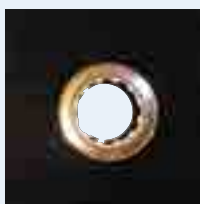

### HL86

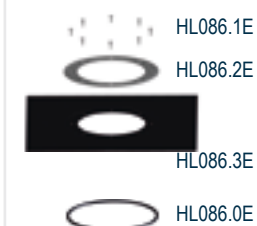
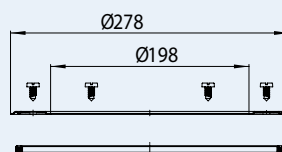
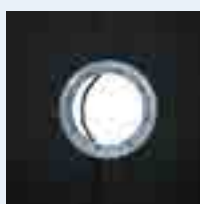

HL-br.	Težina	EAN	Kom./Pak.
83	425 g	+710836	1
8300	601 g	+025466	1
84	730 g	+710843	1
86	590 g	+710867	1



**HL83.H, HL8300.H, HL84.H, HL86.H** Hidroizolaciona garnitura sa bitumenskom kragom

**Podaci**

Materijal	INOX / Bitumen
Dimenzija	<b>HL83.H:</b> Priрубnica Ø 196 x 114 mm Bitumenska kragna 500 x 500 mm <b>HL8300.H:</b> Priрубnica Ø 238 x 148 mm Bitumenska kragna 500 x 500 mm <b>HL84.H:</b> Priрубnica Ø 220 x 155 mm Bitumenska kragna 500 x 500 mm <b>HL86.H:</b> Priрубnica Ø 278 x 198 mm Bitumenska kragna 500 x 500 mm
Preporučeno za	zavarivanje sa bitumenskim kragama
Odgovara za	<b>HL83.H:</b> HL70, HL80, HL90(Pr), HL92, HL300, HL304, HL310N(Pr), HL510N(Pr) kao i za nastavni element HL85N <b>HL8300.H:</b> HL3100(Pr) i HL5100(Pr) kao i za nastavni element HL8500 <b>HL84.H:</b> Modeli krovnih slivnika: HL62, HL64, HL63, Nastavni element: HL65 <b>HL86.H:</b> HL615 i HL616 kao i za nastavni element HL618

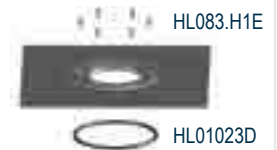
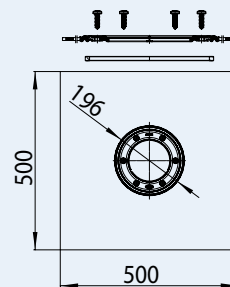
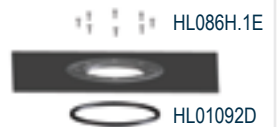
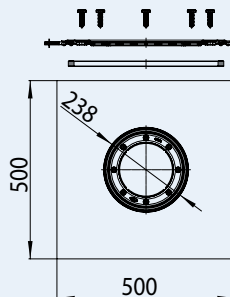
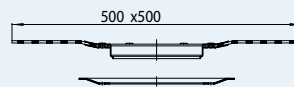
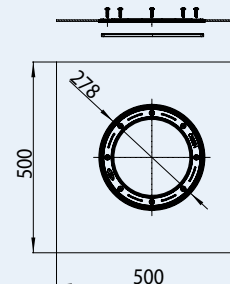
**HL83.H**

**HL8300.H**

**HL84.H**

**HL86.H**

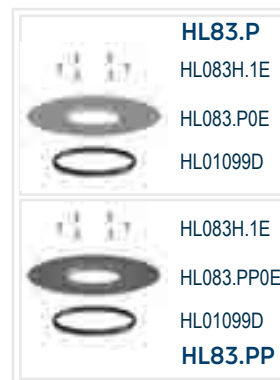
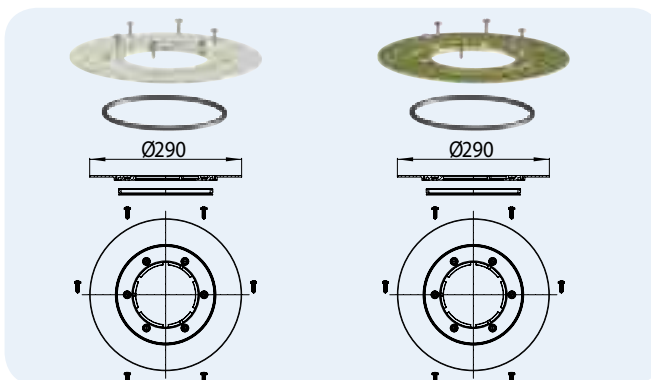
HL-br.	Težina	EAN	Kom./Pak.
83.H	1560 g	+008315	1
8300.H	1560 g	+025480	1
84.H	1707 g	+011841	1
86.H	1590 g	+008612	1

**HL83.P, HL83.PP Hidroizolaciona garnitura sa PVC odnosno PP kragom**
**Podaci**

Materijal	<b>HL83.P:</b> PVC <b>HL83.PP:</b> PP (Polipropilen)
Dimenzija	<b>HL83.P:</b> Prirubnica Ø 290 mm <b>HL83.PP:</b> Prirubnica Ø 290 mm
Preporučeno za	<b>HL83.P:</b> PVC-Hidroizolacije <b>HL83.PP:</b> FPO odnosno TPO Hidroizolacije na bazi PP (Polipropilen)
Odgovara za	HL70, HL80, HL90(Pr), HL92, HL300, HL304, HL310N(Pr), HL510N(Pr) kao i za nastavni element HL85N



HL-br. 83.P 83.PP	Težina 425 g 653 g	EAN +010837 +028641	Kom./Pak. 1 1
-------------------------	--------------------------	---------------------------	---------------------

**HL8300.P, HL8300.PP Hidroizolaciona garnitura sa PVC odnosno PP kragom**
**Podaci**

Materijal	<b>HL8300.P:</b> PVC <b>HL8300.PP:</b> PP
Dimenzija	<b>HL8300.P:</b> Prirubnica Ø 350 mm <b>HL8300.PP:</b> Prirubnica Ø 350 mm
Preporučeno za	<b>HL8300.P:</b> PVC-Hidroizolacije <b>HL8300.PP:</b> FPO odnosno TPO Hidroizolacije na bazi PP (Polipropilena)
Odgovara za	seriju slivnika HL3100 i HL5100 kao i za nastavni element HL8500

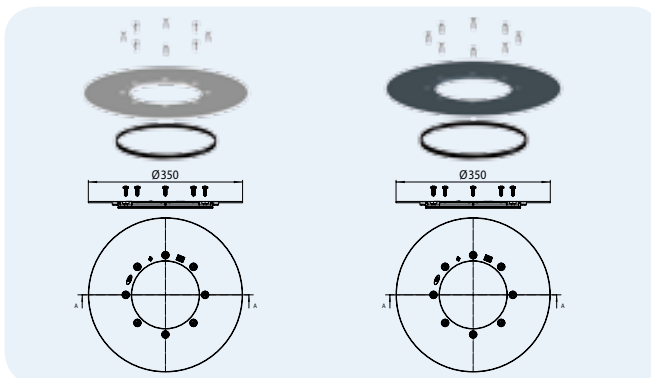

HL-br. 8300.P 8300.PP	Težina	EAN +034741 +034758	Kom./Pak. 1 1
-----------------------------	--------	---------------------------	---------------------

**HL84.CU, HL84.E Hidroizolaciona garnitura sa bakarnim odnosno pocinkovanim limom**
**Podaci**

Materijal	<b>HL84.CU:</b> Bakarni lim <b>HL84.E:</b> Pocinkovani lim
Dimenzija	<b>HL84.CU:</b> 500 x 500 mm <b>HL84.E:</b> 500 x 500 mm
Preporučeno za	<b>HL84.CU:</b> za krovove pokrивene bakarnim limom <b>HL84.E:</b> za krovove pokrивene pocinkovanim limom
Odgovara za	Seriya krovnih slivnika HL62, HL63, HL64, HL65 i HL69

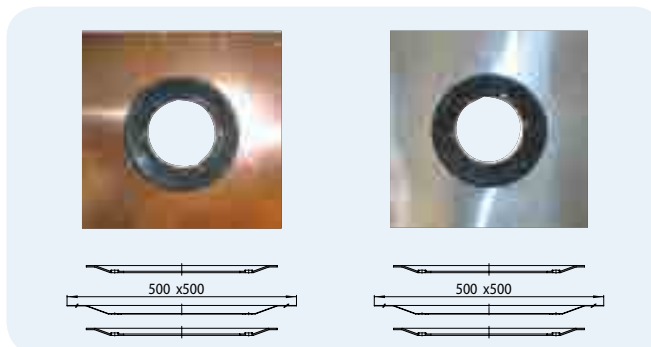

HL-br. 84.CU 84.E	Težina 1835 g 1830 g	EAN +444847 +111848	Kom./Pak. 1 1
-------------------------	----------------------------	---------------------------	---------------------

# HL Nastavni elementi – Proizvodi – Podaci

## HL320, HL340N, HL3400, HL350, HL620 Nastavni element

### Podaci

Materijal	PP (Polipropilen)
Dimenzija	<b>HL320:</b> Ø 89 mm, h: 35 mm <b>HL340N:</b> Ø 110 mm, h: 100 mm <b>HL3400:</b> Ø 146 mm, h: 200 mm <b>HL350:</b> Ø 145 mm, h: 155 mm <b>HL620:</b> Ø 195 mm, h: 125 mm
Preporučeno za	Za podešavanje visine završnog okvira
Odgovara za	<b>HL320:</b> HL92 <b>HL340N:</b> HL70, HL80, HL90(Pr), HL300, HL304, HL310N(Pr), HL510N(Pr) kao i za nastavni element HL85N <b>HL3400:</b> seriju HL3100 i 5100 <b>HL350:</b> HL72.1, HL317, HL62, HL63, HL64, HL65, HL69 <b>HL620:</b> HL615 i HL616

### HL320

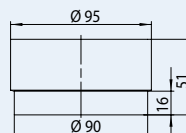

### HL340N

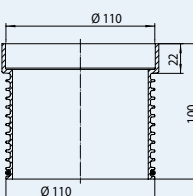

HL01067D

### HL3400

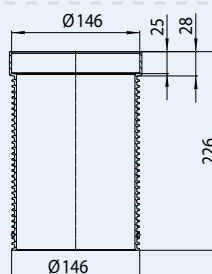

HL01093D

### HL350

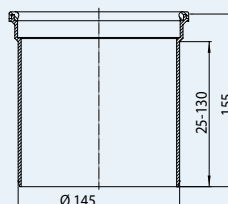

### HL620

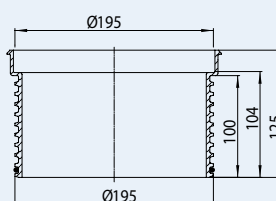

HL01056D

HL-br.	Težina	EAN	Kom./Pak.
340N	75 g	+003402	1
3400	117 g	+025565	1
350	240 g	+703500	1
620	270 g	+014255	1

**HL85N, HL8500, HL350.1, HL350.0, HL618, HL65** Nastavni element sa prirubnicom

**Podaci**

Materijal	PP (Polipropilen)
Dimenzija	<b>HL85N:</b> Ø 110 x 220 mm, h: 227 mm <b>HL8500:</b> Ø 146 x 239 mm, h: 226 mm <b>HL350.1:</b> Ø 145 x 300 mm, h: 220 mm <b>HL618:</b> Ø 195 x 315 mm, h: 155 mm <b>HL65:</b> Ø 125 x 354 mm, h: 345 mm
Preporučeno za	Za podešavanje visine prirubnice slivnika na nivo hidroizolacije
Odgovara za	<b>HL85N:</b> HL70, HL80, HL90(Pr), HL300, HL304, HL310N(Pr), HL510N(Pr) <b>HL8500:</b> HL3100(Pr) i HL5100(Pr) <b>HL350.1:</b> HL72.1, HL317, HL62, HL63, HL64, HL65 i HL69 <b>HL618:</b> HL615, HL616 <b>HL65:</b> HL62, HL64

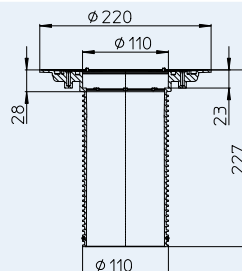
**HL85N**

HL01067D

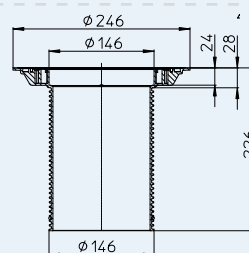
**HL8500**

HL03100.0E

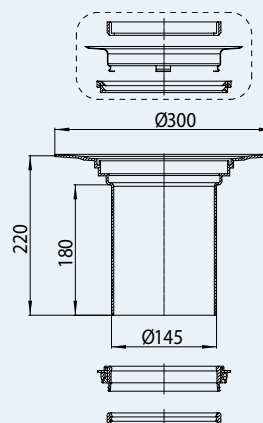

HL01093D

**HL350.1 (HL350.0)**

HL062B.3E



HL084.2E



HL084.3E



HL084.4E

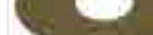

HL01059D

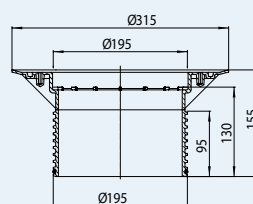

HL01058D

**HL618**

HL01056D

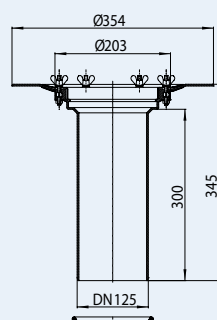
**HL65**

HL062.4E



HL170



HL062.3E



HL01020D

HL-br.	Težina	EAN	Kom./Pak.
85N	395 g	+006120	1
8500	320 g	+025572	1
350.0	680 g	+032358	1
350.1	1440 g	+703517	1
618	500 g	+013159	1
65	1440 g	+800650	1

**HL85NC, HL360 CeraDrain Nastavni element sa polimerno betonskom kragnom**
**Podaci**

Materijal	PP / Polimerni beton
Dimenzija	<b>HL85NC:</b> Ø 110 mm, h: 118 mm, Prirubnica: 260 x 260 mm, Liveno- gvozdjena armatura: 450 x 450 mm <b>HL360:</b> Ø 145 mm, h: 140 mm, Prirubnica: 307 x 307 mm, Liveno- gvozdjena armatura: 503 x 503 mm
Preporučeno za	Specijalno za alternativne hidroizolacije povezane sa keramičkim pločicama. Sa zalivenom polimerno betonskom kragnom i liveno-gvozdenom armaturom, 4 vijaka za podešavanje visine i poliesterskom mrežom za premošćivanje pukotina oko slivnika
Odgovara za	modele slivnika <b>HL85NC:</b> HL70, HL80, HL90(Pr), HL300, HL304, HL310N(Pr), HL510N(Pr) <b>HL360:</b> HL72.1, HL317

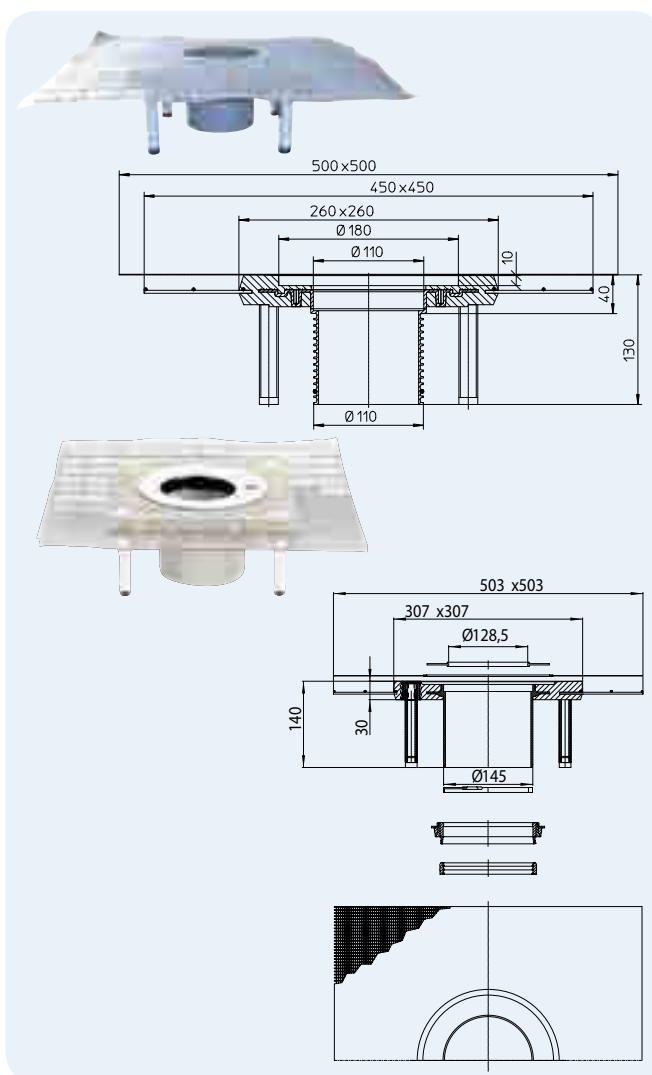
 HL-br.  
85NC  
360

 Težina  
3886 g  
8000 g

 EAN  
+006823  
+703609

 Kom./Pak.  
1  
1

**HL370 Nastavak „FlexDrain“**
**Podaci**

Materijal	ABS
Dimenzija	Ø 145 x 375 mm, h: 150 mm
Preporučeno za	Specijalno za alternativne hidroizolacije povezane sa keramičkim pločicama. Sa rupičastom i geotekstilnom prirubnicom za bolje povezivanje sa hidroizolacijom kao i sa dihtung kragnom za premošćivanje pukotina oko slivnika
Odgovara za	HL72.1 i HL317

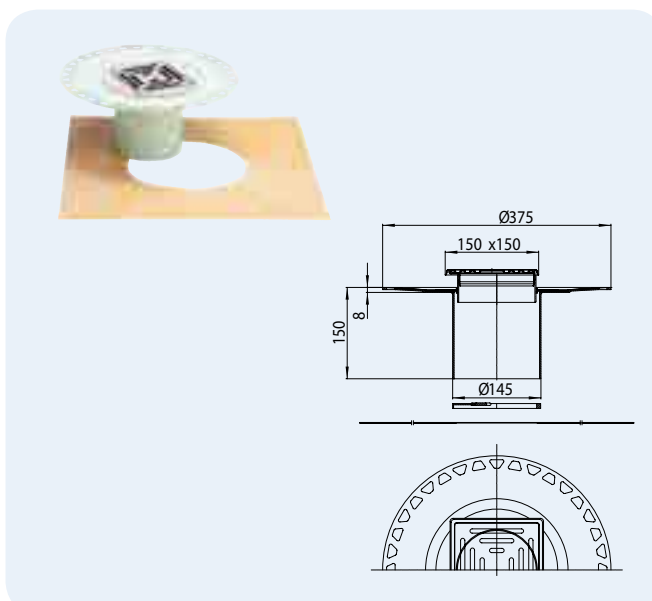
 HL-br.  
370

 Težina  
930 g

 EAN  
+010714

 Kom./Pak.  
1

**HL85NH, HL8500H, HL350.1H, HL618H, HL65H** Nastavni element sa fabrički povezanom bitumenskom kragnom

**Podaci**

Materijal	PP / INOX / Bitumen
Dimenzija	<b>HL85NH:</b> Ø 110 mm, h: 227 mm, Bitumenska kragna: Ø 420 mm <b>HL8500H:</b> Ø 146, h: 226 mm, Bitumenska kragna: 500 x 500 mm <b>HL350.1H:</b> Ø 145, h: 225 mm, Bitumenska kragna: Ø 500 mm <b>HL618H:</b> Ø 195 mm, h: 160 mm, Bitumenska kragna: 500 x 500 mm <b>HL65H:</b> Ø 125 mm, h: 345 mm, Bitumenska kragna: Ø 500 mm
Preporučeno za	Preporučeno za bitumenske kragne
Odgovara za	<b>HL85NH:</b> HL70, HL80, HL90(Pr), HL300, HL304, HL310N(Pr), HL510N(Pr) <b>HL350.1H:</b> HL72.1, HL317, HL62, HL63, HL64, HL65, HL69 <b>HL618H:</b> HL615 und HL616 <b>HL65H:</b> HL62, HL64

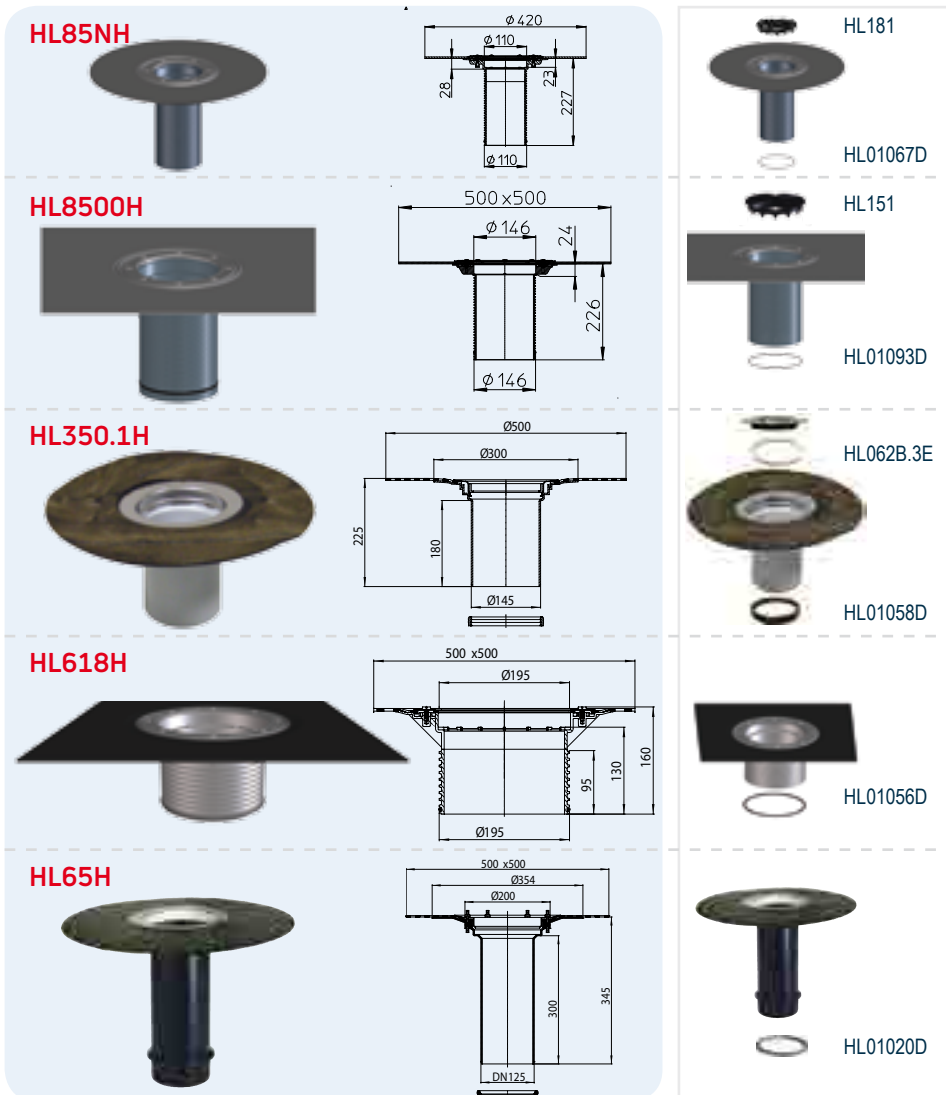

HL-br.	Težina	EAN	Kom./Pak.
85NH	980 g	+009015	1
350.1H	1550 g	+001842	1
618H	1750 g	+013173	1
65H	2140 g	+801657	1

**HL65P, HL65F, HL65PE** Nastavni element

**Podaci**

Materijal	<b>HL65P:</b> PVC <b>HL65F:</b> PP (Polipropilen) <b>HL65PE:</b> PE (Polietilen)
Dimenzija	Ø 125 mm, h: 345 mm, Prirubnica: Ø 355 mm
Preporučeno za	<b>HL65P:</b> PVC-hidroizolacije <b>HL65F:</b> FPO odnosno TPO-hidroizolacije na bazi PP (Polipropilena) <b>HL65PE:</b> FPO-izolacije na bazi PE (Polietilena)
Odgovara za	seriju krovnih slivnika HL62 i HL64

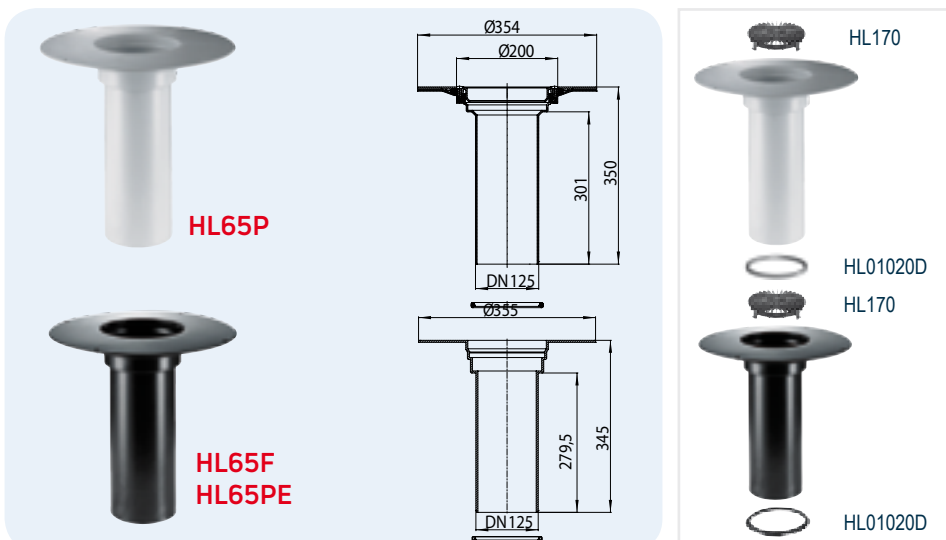

HL-br.	Težina	EAN	Kom./Pak.
65P	1370 g	+022588	1
65F	830 g	+031900	1